

Varenummer: 0118010
 Beskrivelse: Seeger låsering H 3

Mål

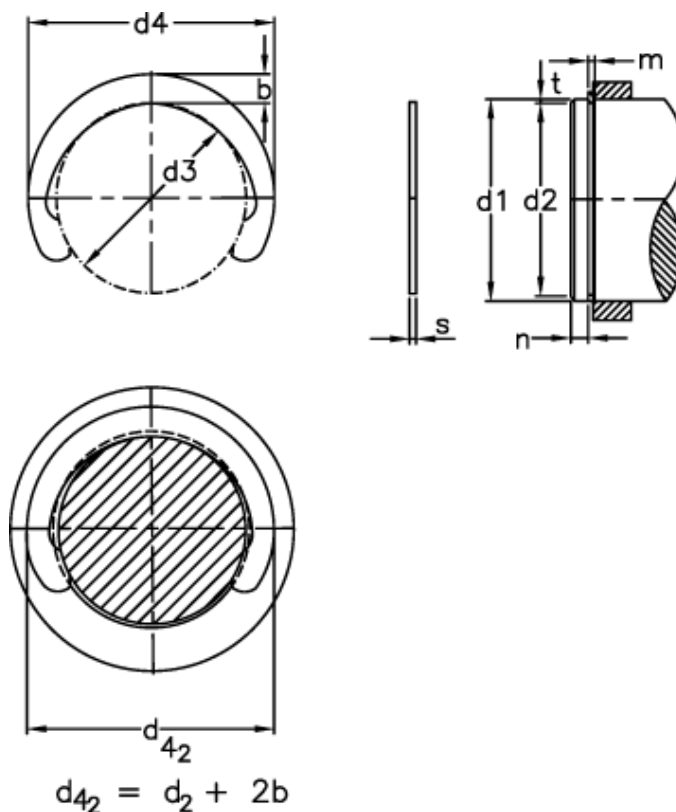

b	= 0.90	FRg kN	= 0.4	t	= 0.35
Betegnelse	= H 3,0	FR kN	= 0.50	tol	= -0.07
d1	= 3	g	= 0.40	tol	= 0.06
d2	= 2.3	Griber	= GRH 3	tol	= -0.05
d3	= 2.18	m min	= 0.44	vægt kg/1000	= 0.02
d4	= 3.98	n abl x 1000	= 95		
d4 2	= 4.1	Nominel træk	= 1.0		
FN kN	= 0.24	s	= 0.40		